

XPERT ***Pro***

Instruction Manual

Please Read Fully
Before Installation

CRITICAL INFORMATION - PLEASE READ THIS BEFORE OPENING YOUR PACKAGE

To get the best from your XPERT Pro – with SAFETY being the utmost priority – it is extremely important that you READ & FOLLOW the Instruction Manual from beginning to end and most importantly, understand it!

Prior to installation, all shrink-wrap covering the pole tubes and parts must be removed. Please DO NOT use a sharp instrument/knife to do this, as damage may be caused to the pole surface.

Follow the simple but explicit instructions in this manual to get the best results from your pole.

Safety is a priority at all times.

If you have ANY questions – before you assemble, install or use your pole – contact your point of purchase or see the X-POLE XPERT Pro section on the website (www.xpole.com – first select your region, then search for the XPERT Pro Section).

ALL REMOVABLE AND PORTABLE POLES USE PRESSURE BETWEEN THE FLOOR AND CEILING TO KEEP THEM STABLE. THERE IS A POSSIBILITY THAT DAMAGE COULD BE CAUSED TO THE CEILING.

VERTICAL LEISURE LTD, X-POLE INTERNATIONAL, X-POLE US INC, THEIR DISTRIBUTORS, SALES PERSONS OR ANY OTHER PERSONS OR ASSOCIATED COMPANIES CANNOT BE HELD RESPONSIBLE FOR ANY DAMAGE TO PROPERTY OR INJURY TO PERSONS OR THIRD PARTIES DURING THE USE OF THIS PRODUCT.

BY REMOVING THE X-POLE XPERT PRO FROM ITS PACKAGING AND/OR ANY USE OF THE PRODUCT CONFIRMS ACCEPTANCE OF THE ABOVE WARNINGS AND THE USER'S RESPONSIBILITY IN USING THE PRODUCT.

IF YOU DO NOT ACCEPT THE TERMS SET OUT ABOVE THEN:

DO NOT REMOVE THE XPERT PRO POLE FROM ITS PACKAGING OR ATTEMPT TO ASSEMBLE, INSTALL OR USE THE PRODUCT.



CAUTION: The XPERT Pro Pole SHOULD NOT be installed under false, suspended or non-rigid ceilings. When searching for Joists please use a step ladder and have a second person holding the ladder providing additional assistance.



CAUTION: Take note that carpet, wooden or sprung floors can affect the stability of this product.



CAUTION: Never undo any of the screws unless you are explicitly told to do so in the instruction manual.

Welcome

“ Thank you for buying an XPERT Pro Pole. The team at X-POLE have spent a significant amount of time researching, designing and developing it.

We want this product to be the world's leading Exercise and Dance Pole, if it's not; we want to understand why not! At X-POLE we thrive on constructive criticism and suggestions! So contact us (details on the back cover) if you have any comments or suggestions on how to improve the product ”

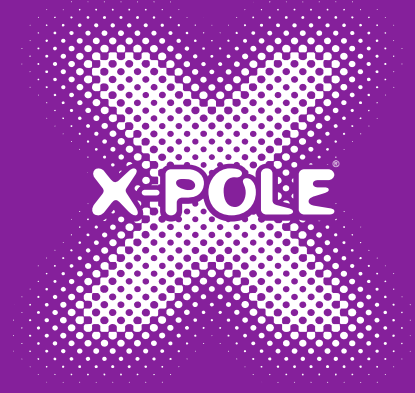

Before using your pole

Mis-using a pole can be dangerous, not only to the user but also to anyone close to the pole. The use of a dance pole is always at the user's discretion, and it is the user's responsibility to check the pole is installed correctly & safely before use.

Pole Exercise is extremely physical and uses muscles that you will not have used before and therefore if you are not warmed up; muscle damage, strains and injury can occur. Before using the pole it is mandatory to warm up and, after use, cool down.

It is highly recommended that before you use your XPERT Pro you purchase a suitable DVD to learn the basic moves. Never try moves beyond your ability without an instructor. If at any time whilst using your pole you feel uncomfortable, your muscles hurt, or you are short of breath – take a break. Always rest between moves & exercise sensibly, if you experience any health issues, seek medical advice.

Have fun with your X-POLE XPERT Pro. The X-POLE Team.

What to wear



Clothing

When it comes to clothing – less is best (unless you have purchased a Silicone Pole). So try to keep your arms and legs uncovered. Pole work needs the friction created by skin contact, so T-Shirts, Crop Tops & Shorts are best. However, you must feel comfortable so wear what you feel relaxed in (tracksuit bottoms, etc.) even though this may mean you are unable to do some of the pole moves properly because of grip.



Footwear

Again comfort is essential. Bare feet (recommended), dance shoes, or trainers can be used but trainers have high friction, so a trainer with a smooth as possible sole is recommended.



Oils and Lotions

NEVER use oils and/or lotion on your hands or body prior to using your pole. This is very DANGEROUS. The oil can transfer onto the pole making it slippery and impossible to hold and this could cause you or someone using the pole after you to have a serious accident.

Product

Fig. (1.1)

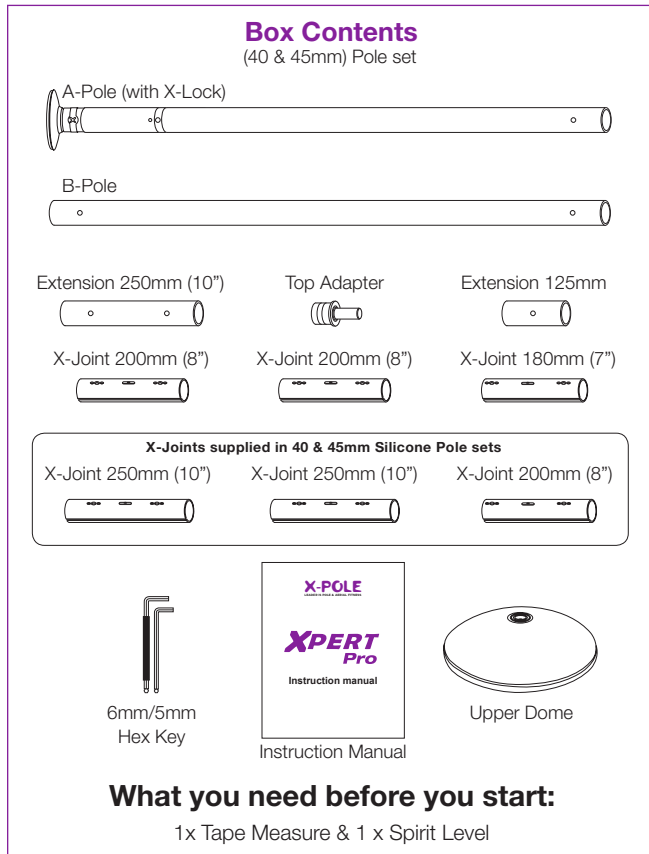
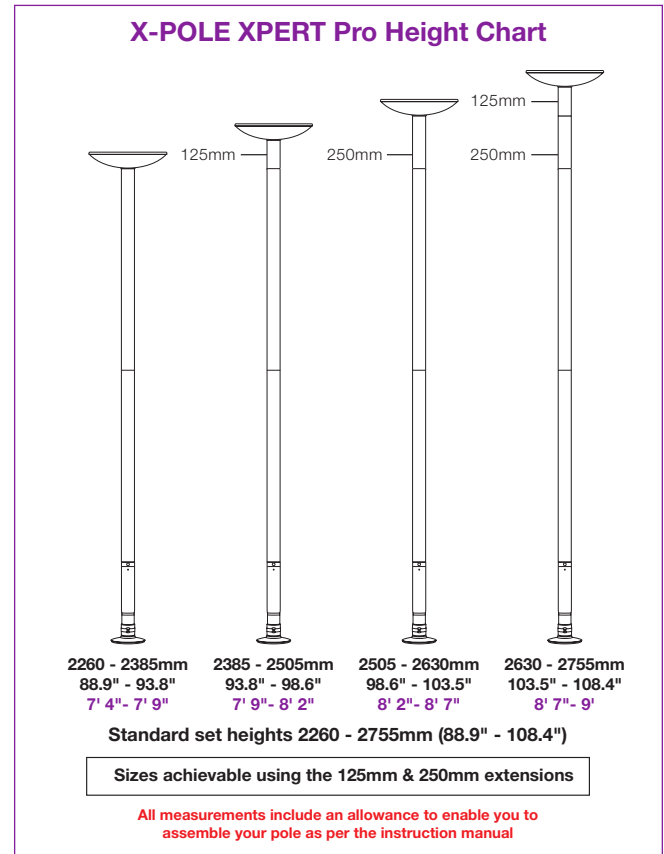

Fig. (1.2)



TIP: Measurement Calculation: 100mm = 10cm = 3.94 inches (or divide the amount of millimetres by 25.4 to get inches): ALWAYS use millimetres or inches for measurements (NOT cm & ft)

Checking the parts

Please check the contents of your XPERT Pro pole with the contents diagram (Fig 1.1). If anything is missing or damaged, please contact your point of purchase. Please study the contents and the part descriptions in the diagram [Fig 1.1] as these are used throughout the instruction manual and are important for installation.

X-Pole Xpert Pro height chart

Using the full (125mm/5") allowed length of the Adjuster Unit (which adjusts the height of the pole) & both included extensions (125mm/5" & 250mm/10") will allow the XPERT Pro to fit ceilings between the ranges of 2260mm (88.9") to 2755mm (108.4"). If you have a ceiling which is higher than 2755mm (108.4"), you will need to purchase additional/ optional extensions from our website www.xpole.com (first select your region, then search for the 'Extensions' section) or from your point of purchase.

The A-Pole Adjuster Unit has the capability of extending the XPERT Pro pole by 125mm (5"). With Adjuster Unit closed (contracted) you will be able to achieve a height of 2260mm (7'4) & with it open (extended) using both the supplied extensions, you will achieve a height of 2755mm (9').

CAUTION: You should NEVER use more than 125mm (5") of the Adjuster Unit.

TIP: Home Poles are suitable for heights up to 3390mm. For heights above this, please contact your local X-POLE office regarding Dual-lined one-piece and multi-piece poles.

Choosing the best place for your X-Pole

Try to find a suitable area in the centre of your room, where you would like to install your pole. Above this area, you will need to locate a 'Joist', please see instructions below on how to do this.

Fig. (2.1)

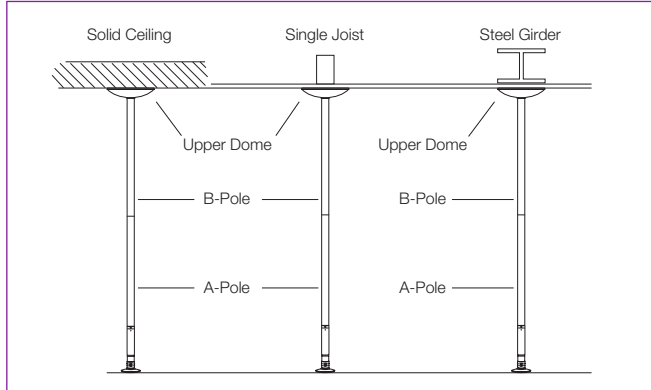

The XPERT Pro must be installed in the most secure location possible, like under a solid ceiling – if you do not have a solid ceiling, you will have to locate a 'Joist' or 'girder' to install the upper dome against.

Fig. (2.2)

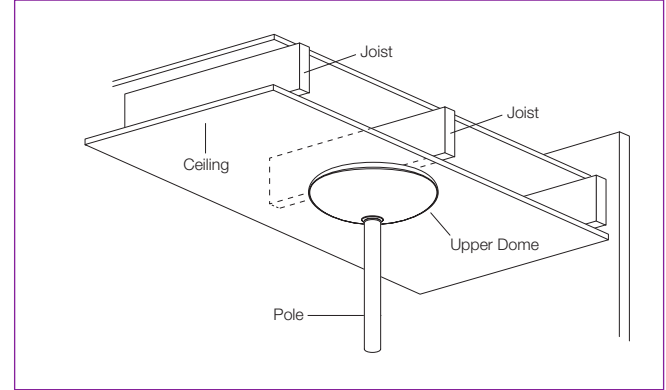

Joists are beams of wood that run from wall to wall and support your ceilings. The Upper Dome must be centred under the Joist.

Fig. (2.3)

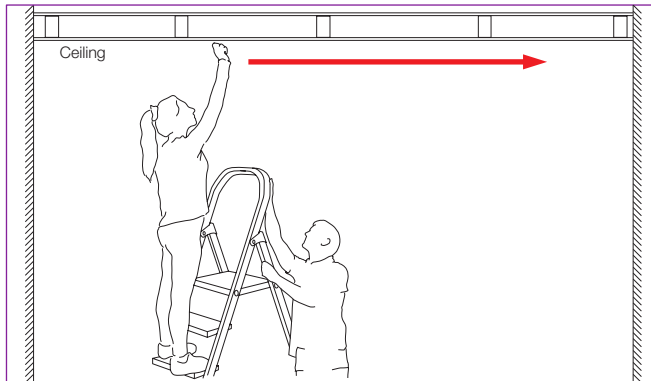

To find a Joist above your ceiling, tap across the ceiling with your knuckle until a solid sound is heard – this will be the Joist. If you keep tapping across the ceiling the sound will become hollow – the space between the Joists.

Fig. (2.4)

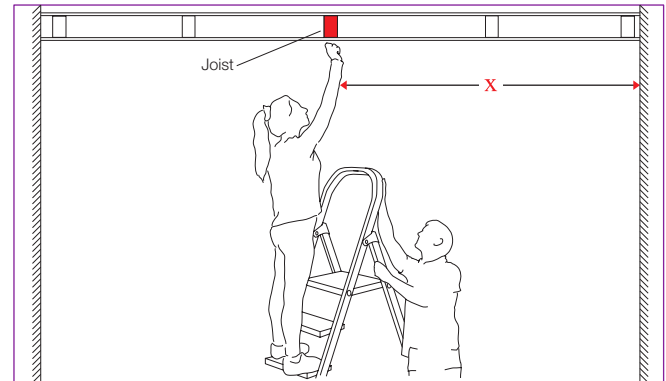

Once a Joist is located, take a position measurement from the wall for future reference. Write this measurement here: **X =**



TIP: Joists can be located using an optional Joist/stud finder; this can be purchased from most hardware stores.

Finding a suitable exercise & dance area



TIP: Measure a circle with a diameter (measured from one point of a circle across to another) of approximately 3000 – 3500mm (120” – 138”) and locate your pole in the centre of the circle.

Fig. (3.1)

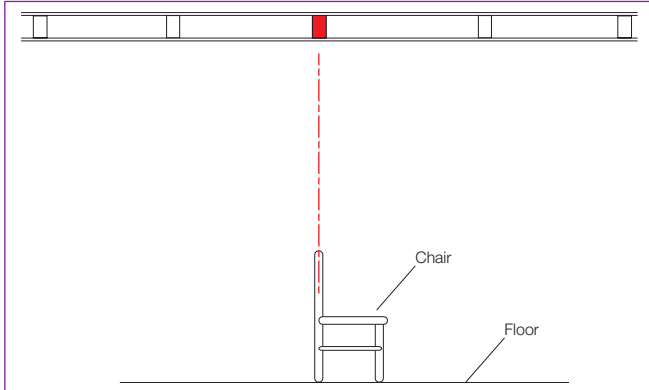

Place a chair beneath the location where you have identified your Joist OR imagine a fully assembled pole beneath this spot.

Fig. (3.2)

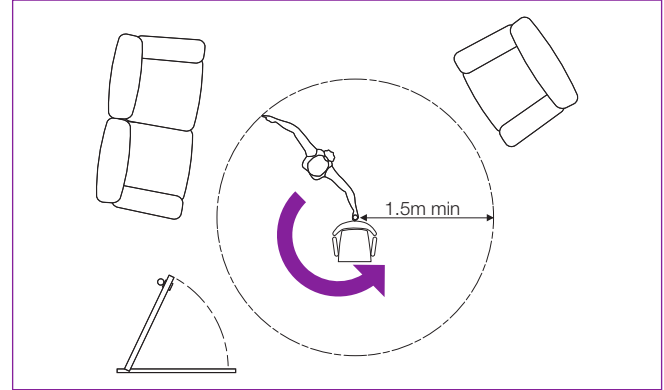

Fully stretch both your arms & place one hand on the chair/imaginary pole and walk around it in a circular motion.

Fig. (3.3)

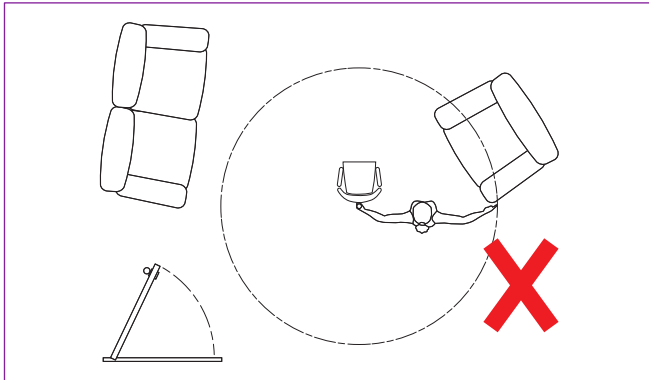

Whilst rotating around the chair/imaginary pole you must not hit or touch anything else in the room.

Fig. (3.4)

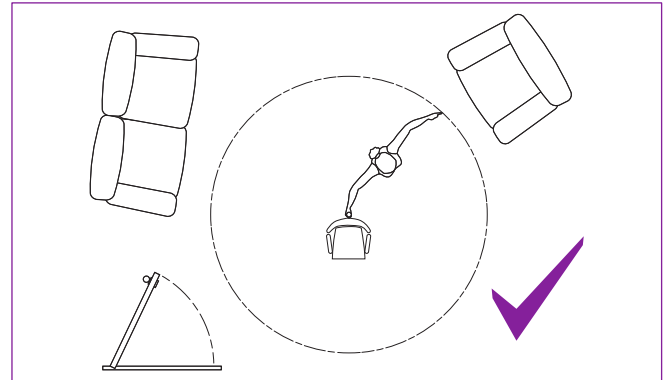

This area will enable you to fully extend your arms & legs when using the pole.

Fig. (3.5)

Measuring the Height of the Ceiling

Accurately measure the height of the ceiling at the point of use and match the ceiling height to the pole height on the chart [Fig 1.2]



TIP: If longer extensions are required (than those supplied in the standard set), then a key point is to minimise the number of extensions & joints used for a given height requirement; i.e. if the required extension length is 500mm – it is better to use:

1 x 500mm extension & 1 x X-Joint rather than 2 x 250mm extensions & 2 x X-Joints.

Home Poles are suitable for heights up to 3390mm's. For heights above this, please contact your local X-POLE office regarding Dual-lined one-piece and multi-piece poles.



CAUTION: Home poles are not suitable for studio use.

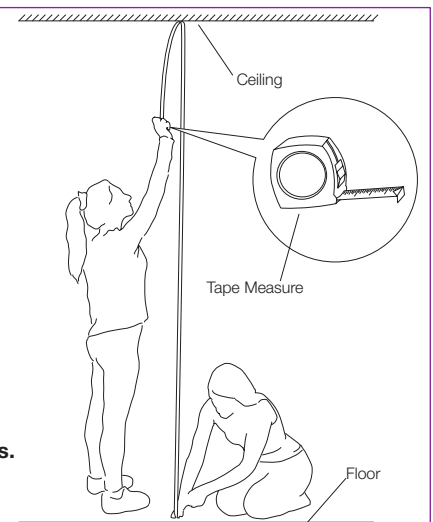

Now you have found a suitable exercise area & the ideal spot for the installation of your pole.

How does X-Poles X-Joint work?

X-POLES use a revolutionary joint called the X-Joint that expands inside the pole tubes to lock them together and stops them from coming apart/separating. To optimise the X-Joint's key features and ensure correct operation, it is important that you carefully follow these instructions. **X-JOINT OPERATION: PLEASE NOTE: ANTI-CLOCKWISE = COUNTER CLOCKWISE**

Fig. (4.1)

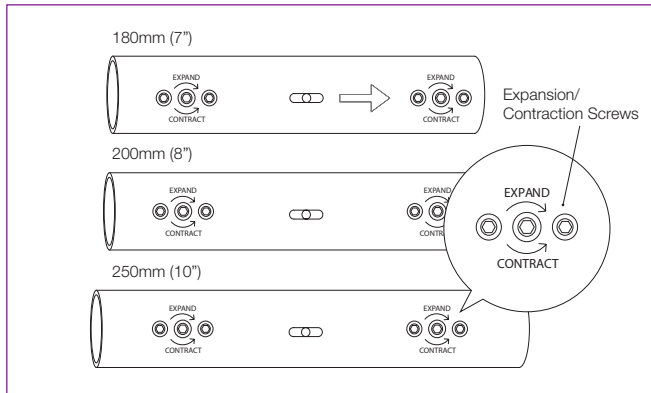

There are 3 sizes of X-Joints; 180mm (7"), 200mm (8") & 250mm (10"). The XPERT Pro is supplied with:

40mm:	1 x 200mm (8")	2 x 250mm (10")
45mm:	1 x 180mm (7")	2 x 200mm (8")

Fig. (4.2)

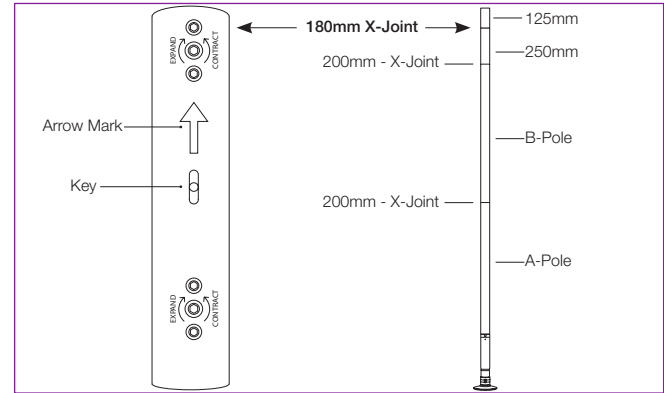

The 180mm (7") X-Joint has one half longer than the other & is marked with an arrow (on the shorter end), when used, this must be installed at the top of the pole with the arrow pointing upwards.



CAUTION: The 180mm X-Joint (200mm in the case of 40mm & silicone poles) should only be used with the 125mm extension.

Fig. (4.3)

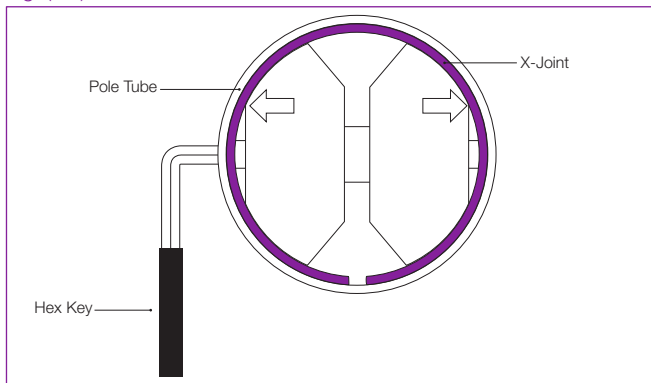

The X-Joint features a special mechanism which expands/contracts to lock/loosen the pole tubes together. Please test this prior to assembly.

Fig. (4.4)

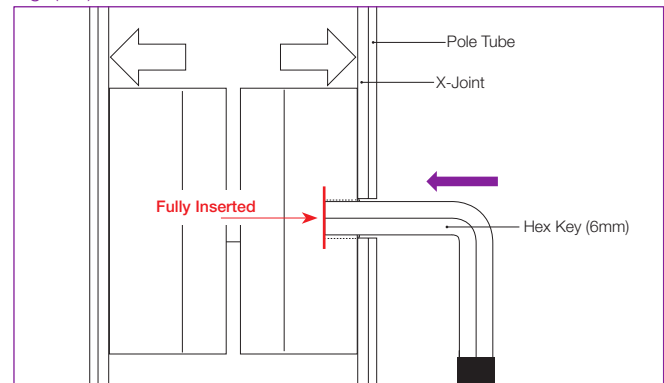

The Joint expansion is done by FULLY inserting the 6mm **Hex Key** (with black plastic cover) into the pole tube & rotating clockwise.

Always remember:

TO EXPAND/TIGHTEN: Clockwise

TO CONTRACT/LOOSEN: Anti/Counter-Clockwise



TIP: Before pole installation test the operation of the X-Joint on its own and then with 2 x Extension Tubes. It is better to gently/ loosely tighten the X-Joints and then undo and firmly re-tighten them when the pole is in place, as when the pole is vertical, the weight/pressure of the pole tubes will push the joints tightly together.

Fig. (4.5)

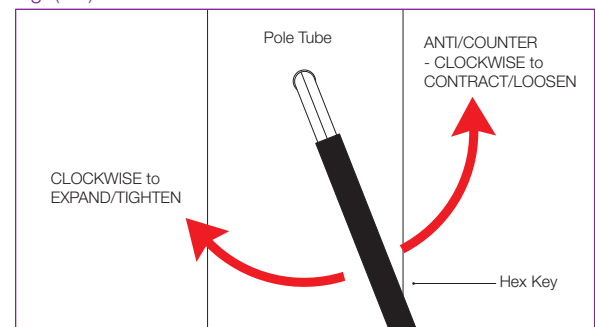

Assembling your X-Pole

Connecting the A-POLE (main tube & base) to the B-POLE.

Fig. (5.1)

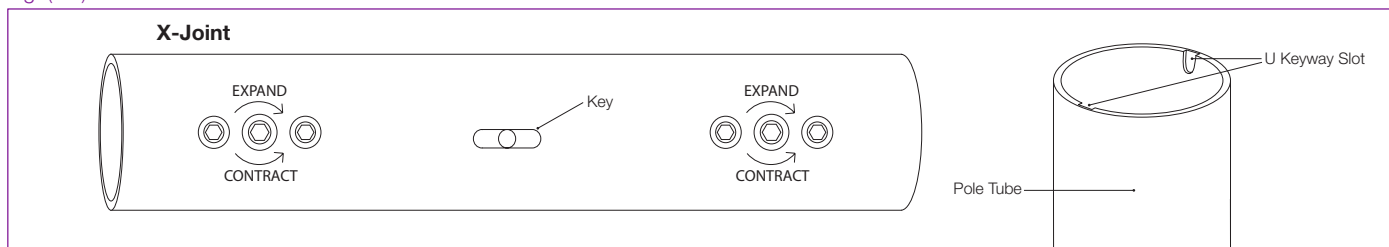

At the centre of the X-Joint are 2 x Keys. These Keys slide into the corresponding U Keyway slots in the pole tube.

Fig. (5.2)

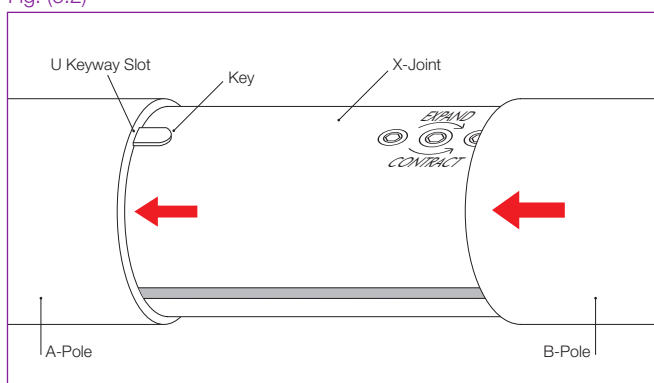

Insert a 200mm X-Joint (250mm X-Joint for 40mm and Silicone poles) into the A-Pole ensuring the keys locate into the U Slots and the expansion screws line up with the holes on the pole tubes. Next attach the B-Pole to the A-Pole with the X-Joint ensuring the Keys engage with the U Keyway Slots.

Fig. (5.3)

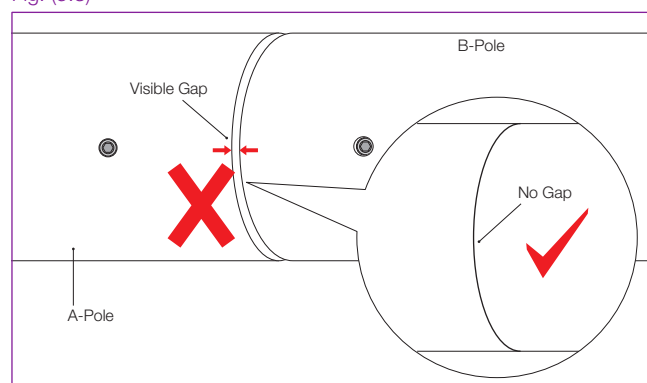

Check the tube edges are tight together – then gently tighten the screw in the A-Pole – now gently tighten the other tube (B-Pole) – continue to progressively tighten each, alternating between the two until no further force can be applied to the screws.

Fig. (5.4)

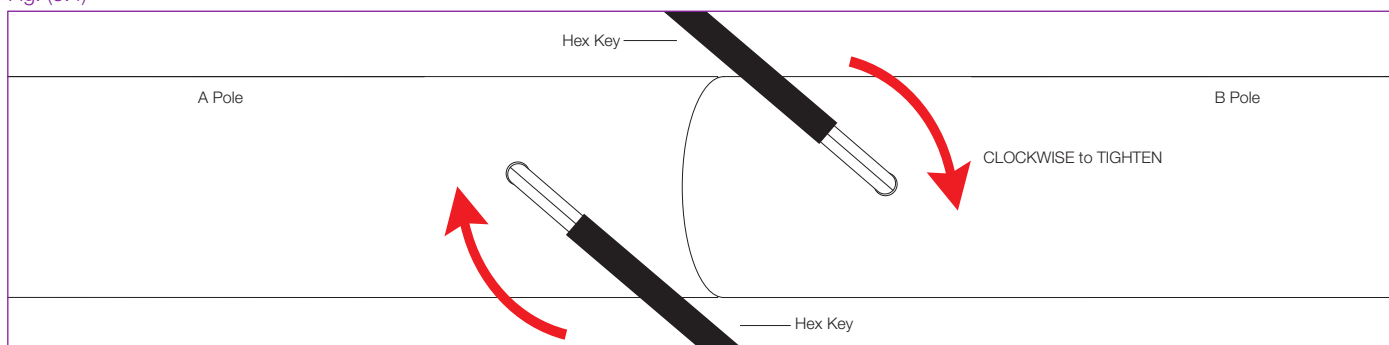

CAUTION: It is important to tighten the screws progressively – alternating between the screws, tightening Clockwise. This will ensure the X-Joint pressure is equalised within the pole tubes. Failure to do so can permanently damage your pole. Joints need tightening regularly and should be checked each time before using the pole.



Scan QR
for full YouTube
demonstration video
on the X-Joint

LEADERS IN POLE & AERIAL FITNESS

Fig. (5.5)

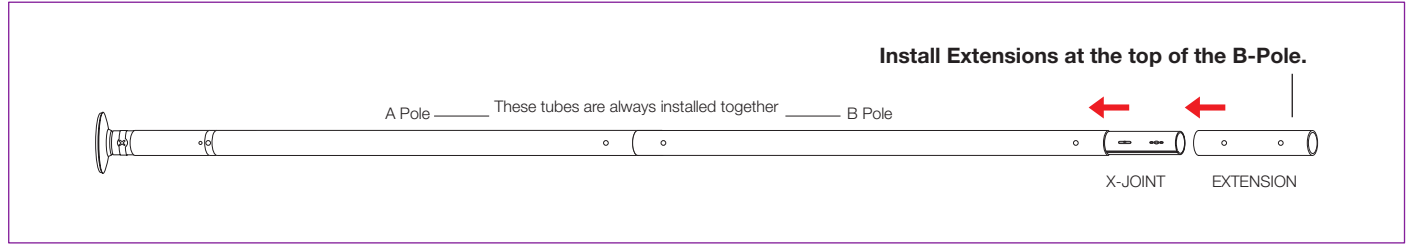

Then, as required, keep adding X-Joints and Extensions to reach your desired height – minimising the number of joints and extensions by using optional longer extensions, available from our online shop; www.xpole.com (first select your region, then search for 'Extensions') or local supplier.

Fig. (5.6)

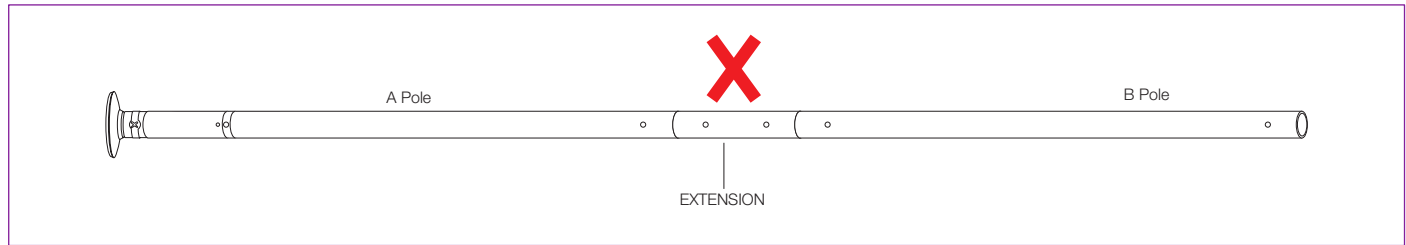

NEVER INSTALL EXTENSIONS IN THE MIDDLE OF THE POLE – THIS IS DANGEROUS. ALWAYS INSTALL EXTENSIONS AT THE TOP OF THE B POLE.



TIP: If longer extensions are required (than supplied in the standard set), then a key point is to minimise the number of extensions & Joints used for a given height requirement; i.e. if the required extension length is 500mm – it is better to use [1 x 500mm extension & 1 x X-Joint] rather than [2 x 250mm extensions & 2 x X-Joints].

Get to know your X-Pole adjustable parts

Fig. (6.1)

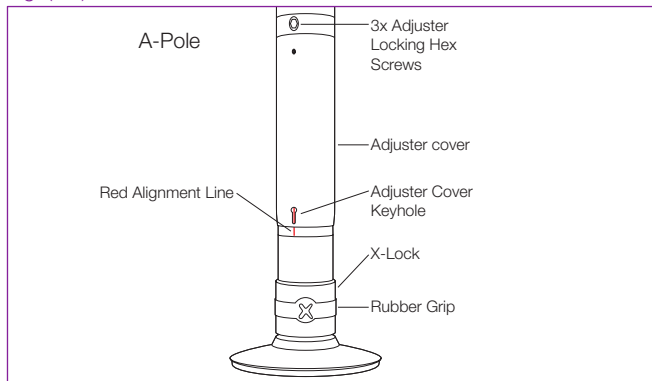
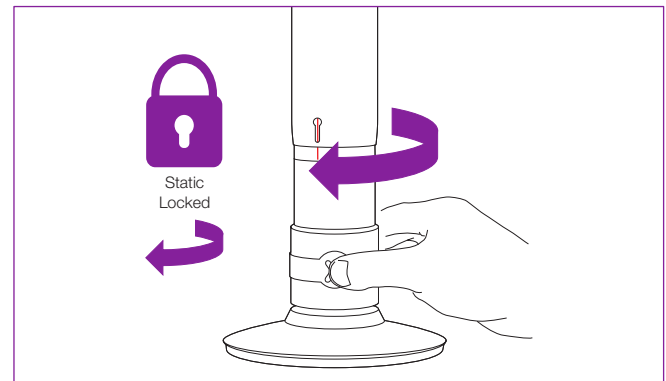
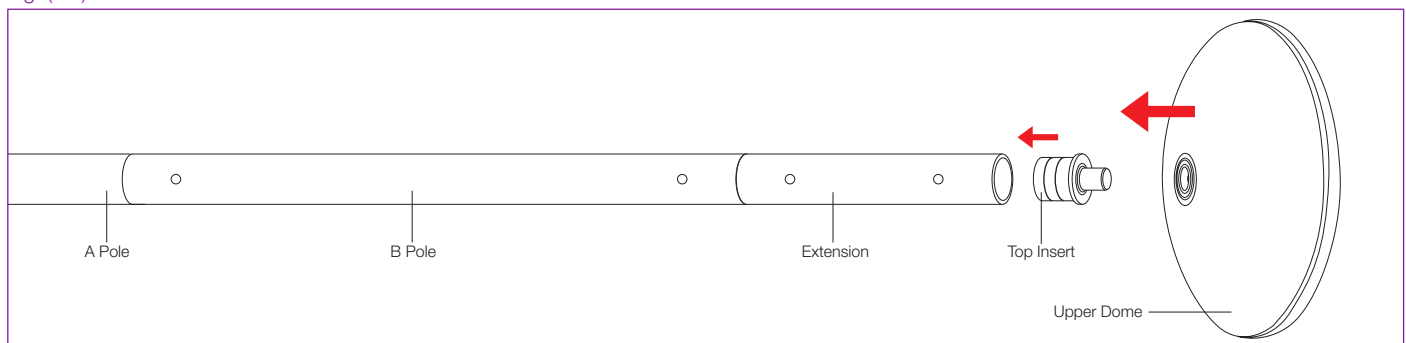

Fig. (6.2)



Inserting the top insert and upper dome

Fig. (7.1)



Once the A-Pole and B-Pole (and any additional extensions) are connected, insert the Top Insert into the B-Pole or last extension used, then slide the upper dome onto the top insert.

BE CAREFUL WHEN YOU LIFT THE ASSEMBLED POLE, TO INSTALL, THAT THE UPPER DOME DOES NOT FALL OFF, AS IT IS LIFTED INTO POSITION. TWO PEOPLE ARE RECOMMENDED FOR 1ST INSTALLATION

CAUTION: DO NOT FORGET: If you are using extensions, you can ONLY use a 180mm X-JOINT (200mm in the case of 40mm & silicone poles) with a 125mm extension and make sure the ARROW on the X-JOINT is always pointing towards the ceiling.

Installing Xpert pro

CAUTION: When assembled, the pole is heavy and at full height, NOT easy to handle. It is therefore MANDATORY/COMPULSORY that 2 people install the pole – i.e. 2 people should lift it into position and 1 person hold the pole while the other rotates/expands the height adjuster.

Make sure that the base of the pole is at the centre point of your dance area – as explained in 'Finding a suitable exercise & dance area' [Fig 3.1- 3.4] and under the selected Joist [Fig 2.4].

LEADERS IN POLE & AERIAL FITNESS

Fig. (8.1)

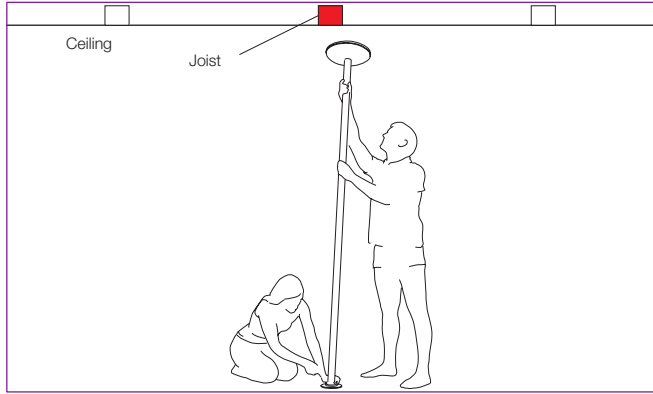

With one person holding the base, the other person should slowly and carefully lift the pole, raising it until it is vertical and under the Joist. **DO NOT** kick into position.

Fig. (8.2)

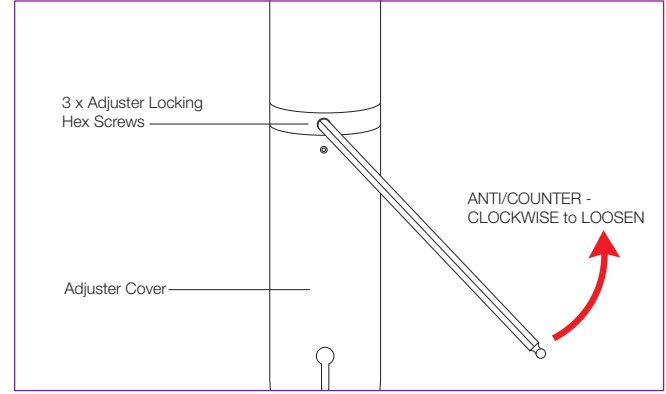

Now undo the 3 Adjuster Locking Hex Screws at the top of the Adjuster Cover with the 5mm Hex Key - a minimum of 2 whole turns. **DO NOT** completely remove the screws and ensure the X-LOCK is locked in static/non-spinning mode by turning it clockwise.

Fig. (8.3)

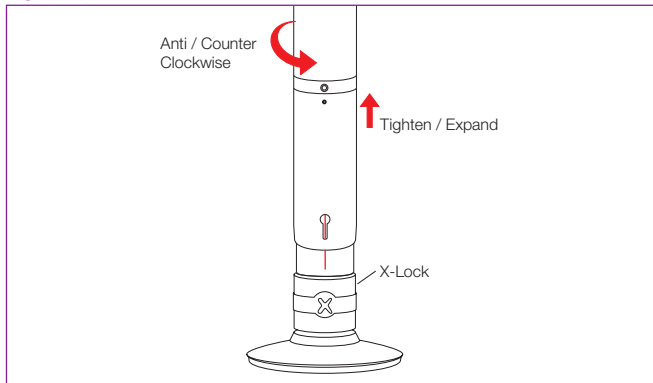

Pole Expansion: Rotating the main pole tube from left to the right (Anti/Counter-Clockwise) will Expand/Tighten the Pole. Rotating the pole tube from right to the left (Clockwise) will Shorten/Loosen the Pole.

Fig. (8.4)

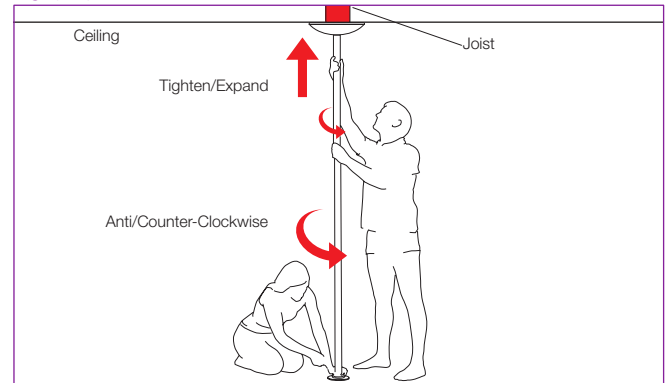

Once vertical, with the second person still holding the base, rotate the pole, Anti/Counter-clockwise (i.e. rotate left to right) which will expand the pole until it touches the ceiling.

Fig. (8.5)

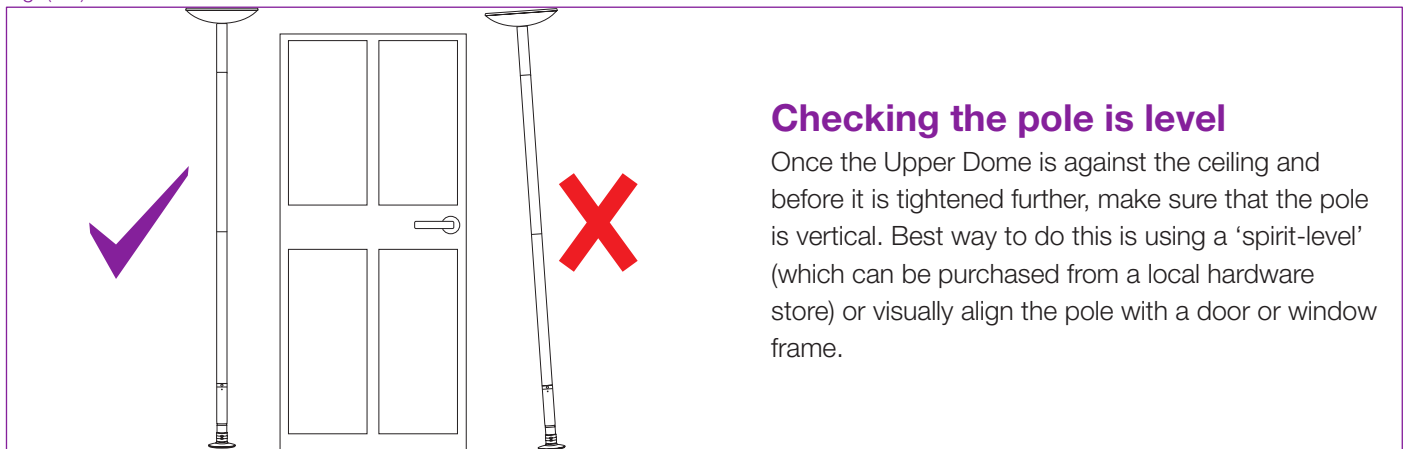

Checking the pole is level

Once the Upper Dome is against the ceiling and before it is tightened further, make sure that the pole is vertical. Best way to do this is using a 'spirit-level' (which can be purchased from a local hardware store) or visually align the pole with a door or window frame.

X-POLE®

Fig. (8.6)

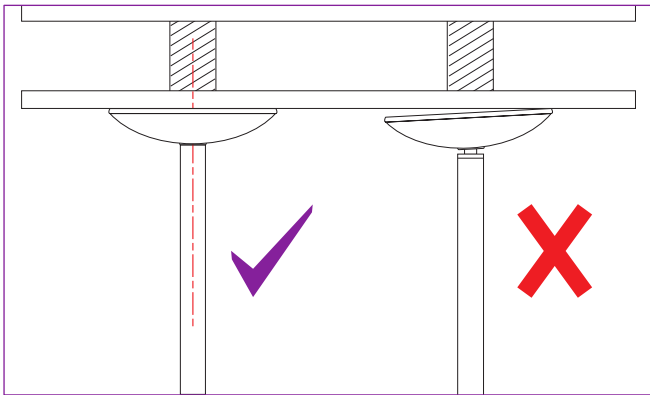

It is critical that the Upper Dome is flat against the ceiling/Joist. DO NOT expand the adjuster further until the upper dome is flat against the ceiling/Joist. If the Upper Dome is not flat, the plate could rotate, and slip or damage the ceiling.

Fig. (8.7)

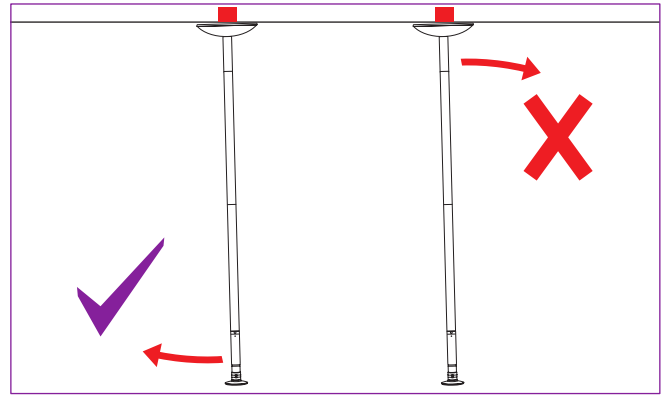

If the pole is not vertical, move the base into the required position. DO NOT move the Upper Dome which must be kept over the centre of the joist at all times. To move, undo the pole and reposition, DO NOT KICK THE BASE INTO POSITION.

Fig. (8.8)

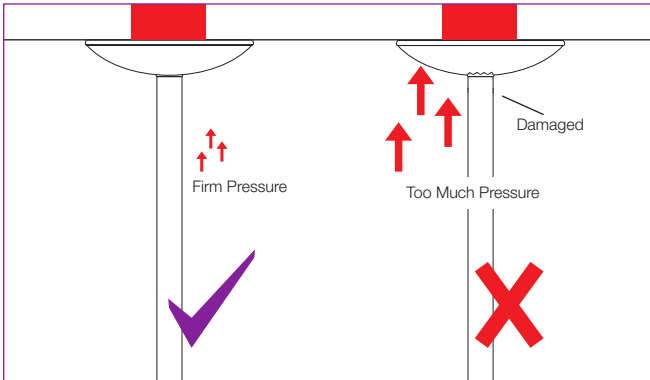

Tighten the pole until positive pressure is felt and the pole is firmly in place. DO NOT exert too much pressure. Rock/Shake the pole to ensure it does not move from its position. Now change pole mode to 'Spin'. Spin the pole gently with your hands, if the pole rotates smoothly, your pole has been tightened correctly. If the pole DOES NOT rotate smoothly, it has been OVERTIGHTENED. In this instance, lock the X-Lock and loosen the pole half-a-turn. Repeat until pole rotates smoothly.

Fig. (8.9)

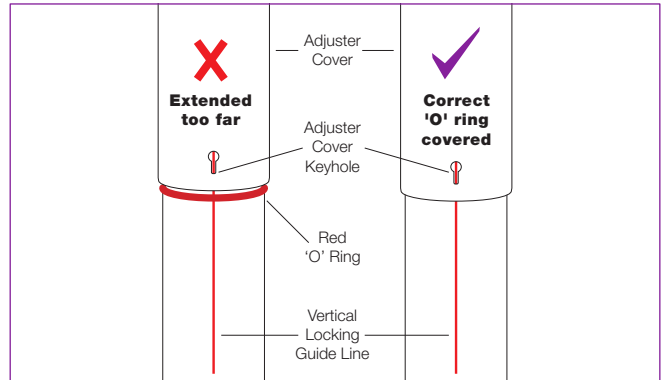

When expanding/unwinding the pole Anti/Counter-clockwise, the adjuster cover will rise. If a red 'O' ring on the adjuster is exposed, this indicates that the adjuster is over extended and you will require an additional extension to use your pole which can be purchased from our website www.xpole.com
DO NOT USE AN OVEREXTENDED POLE

Fig. (8.10)

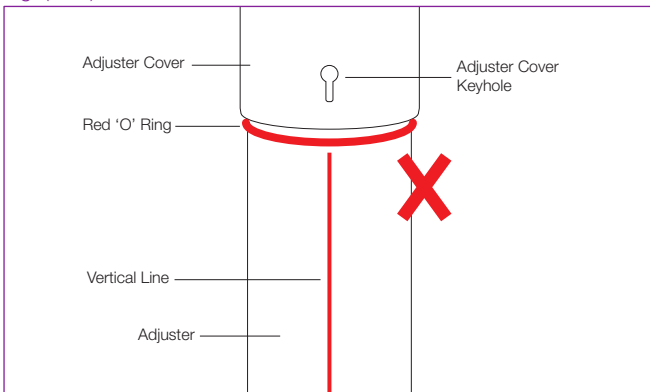

CAUTION: Vertical line must be aligned with the adjuster cover keyhole to prevent permanent damage to your pole.

If ANY of the red 'O' ring is exposed, the adjuster is at its maximum allowed length (125mm/5"). It is now mandatory/compulsory to use the supplied extensions or purchase an additional extension, available from our website www.xpole.com

DO NOT extend the pole beyond the red 'O' ring.

Fig. (8.11)

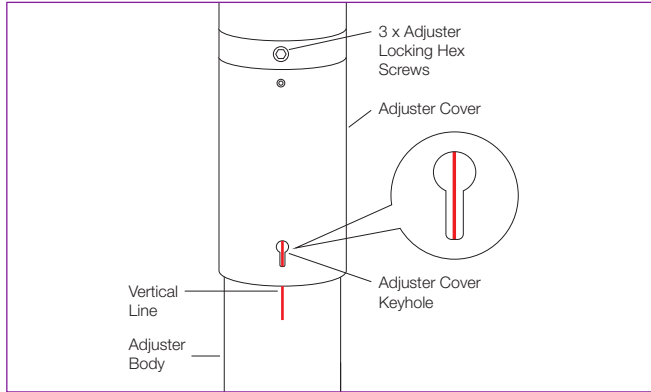

Once the pole is tight, rotate the pole till the Adjuster Cover Keyhole is in alignment with the red vertical line on the Adjuster. This will ensure that the screws are on the flats. Failure to do so will permanently damage your pole. Now tighten the 3 Adjuster Locking Hex Screws tightly with a 5mm Hex Key to lock the A-Pole.

Fig. (8.12)

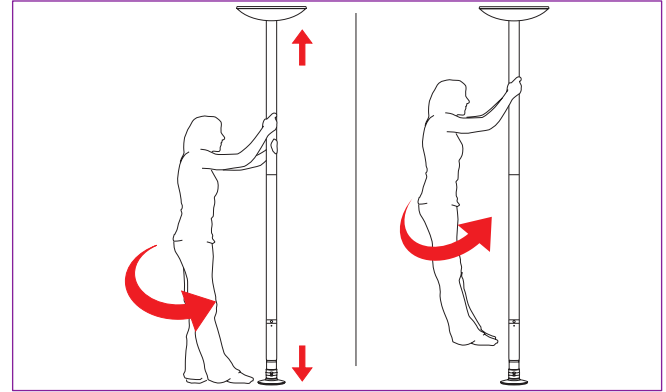

Once the pole feels tight and does not move, try practicing a turn with at least one **foot on** the floor. Re-tighten as necessary until there is no movement. Once you are certain that the pole has been installed safely - try a move with your **feet off** the ground.

Your XPERT PRO is now ready for use.



CAUTION: Vertical RED line must be aligned with the adjuster cover keyhole to prevent



TIP: If the floor is not solid (concrete), it helps, once the pole is tight, to have someone stand on the base and then re-tighten. This compresses the floor and also makes it easier to rotate the pole.



CAUTION: Do not over-tighten the XPERT Pro Pole - only tighten till good positive pressure is felt and the pole is firmly in place.

Static to Spin

Fig. (9.1)

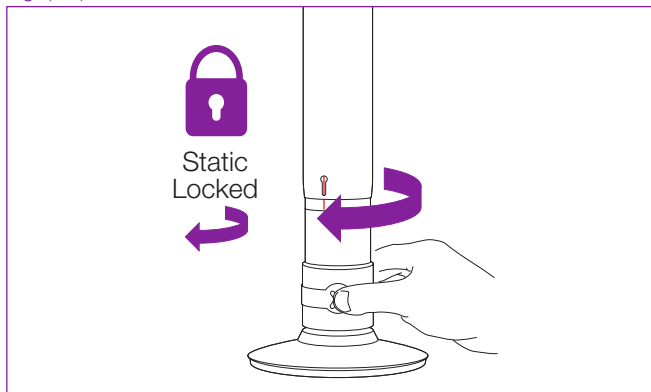

To place your XPERT Pro in static mode, twist the rubber grip clockwise.

Fig. (9.2)

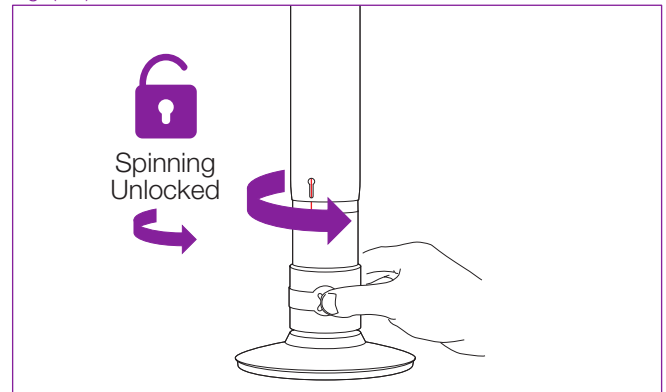

To place your XPERT Pro in spinning mode, twist the rubber grip counter clockwise.



TIP: If the X-LOCK does not fully engage, it may be necessary to slightly rock the pole as you twist the X-LOCK rubber grip.

Pole maintenance & removal

Fig. (10.1)

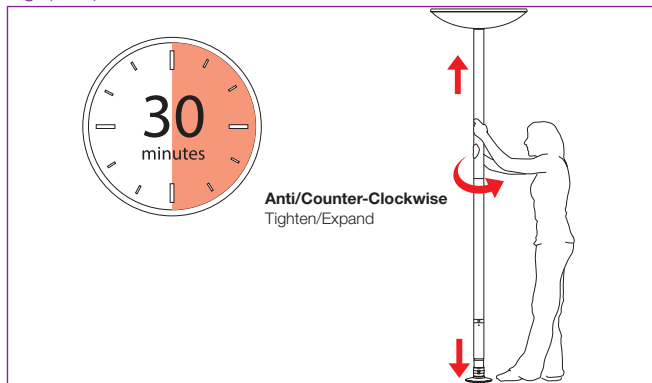

Because the XPERT Pro pole uses pressure to remain in position. The pole tightness and X-Joints should be checked regularly during use, ideally every 30 minutes.

If there is any movement, DO NOT USE, until you have re-tightened. Always check the X-Joints at the same time.

Fig. (10.2)

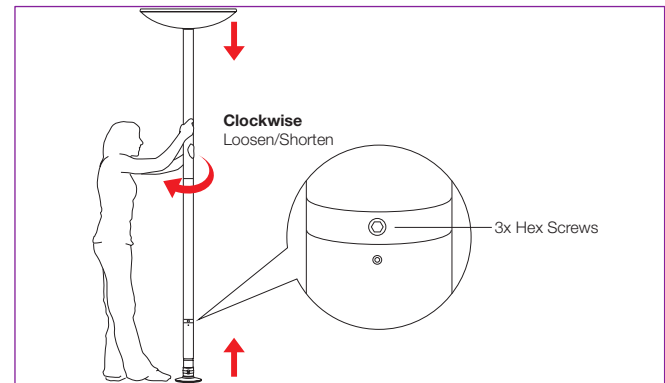

To take down the pole, ensure the X-Lock is in static/non-spinning mode and undo the 3 x Hex Adjuster Locking Screws (DO NOT completely remove the screws). Then turn the pole clockwise to contract/release the pole. Once the pole has been removed from its position, the Upper Dome can be removed.

Fig. (10.3)

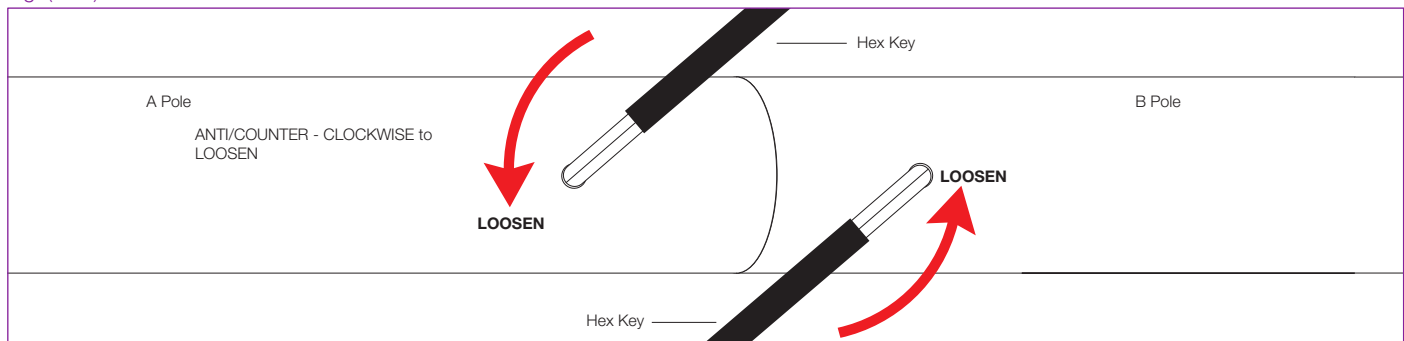

Lay the pole tubes on the floor and undo the X-Joints to disassemble the XPERT Pro. To undo the X-Joint – turn both Hex Screws **Anti/Counter Clockwise** – undo screws until there is pressure against the key.



CAUTION: Store your Xpert Pro pole only in a warm, dry place

Cleaning your pole

Fig. (11.1)



X-Clean & Micro-Fibre Cloths

X-POLE strongly recommends the use of X-CLEAN with our specially designed Micro-Fibre Cloths to clean and maintain the surface of your XPERT Pro Pole. You can purchase these items from our website www.xpole.com (first select region, then search for X-CLEAN) or your point of purchase.

DO NOT USE X-Clean on Brass, Powder Coated or Silicone Poles.

Accessories

Home Mount

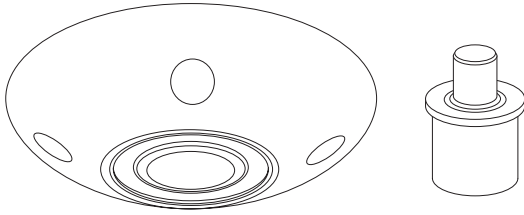

*Designed to be discreet and minimalist, the Home Mount is the perfect way to securely install your X-POLE with a permanent mount, minimising the visual impact of a pole mount. Available in Powder Coat White, Chrome and Titanium Gold.

Vaulted Ball Mount

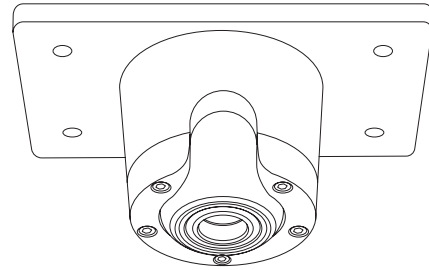

*For permanent pole installation and maximum stability & safety, the Vaulted Ball Mount can be installed on flat or angled ceilings. Available in Chrome or Titanium Gold.

Xpert Pro Carry Case

Item No. PX-CS01



*The XPERT Pro Carry Case allows you to easily store your pole and take it anywhere, along with a spare sleep for additional extensions and X-JOINT'S

Extensions

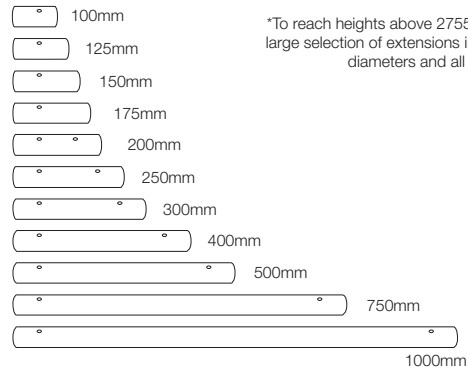

*To reach heights above 2755mm's, we have a large selection of extensions in 40mm & 45mm diameters and all available finishes.

Pole Away

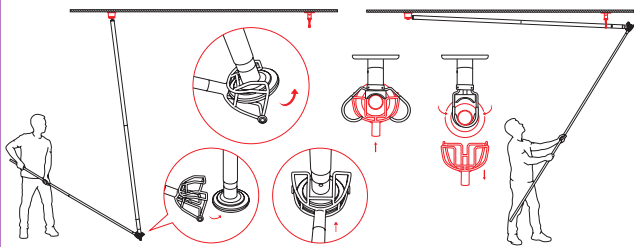

Not for Home Pole Use, Only Studio Poles

X-Clean



*The ideal solution to clean and care for your X-POLE. Not suitable for Brass, Silicone or Powder Coat poles.

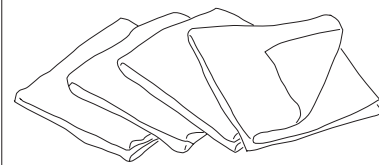

Item No. X-CLEAN

Additional Assistance Section

PLEASE NOTE: ANTI-CLOCKWISE = COUNTER CLOCKWISE

(A) As damage can occur from the pressure used to keep the XPERT Pro Pole in place, it is mandatory that the pole is centred under one joist. The better aligned the upper dome is under the centre of the joist and the more care taken in assembly and set-up, the less potential there is for damage.

(B) Most plasterboard or plaster ceilings, will flex/compress with pressure. This means that the retaining nails/pins/screws can be pushed out of the plasterboard when pressure is applied by the pole adjuster. If this happens, just re-nail or re-tighten the fixing screws, fill and re-paint.

Visit us at: www.XPOLE.com

X-POLE®

LEADERS IN POLE & AERIAL FITNESS

X-POLE UK & EUROPE
Email: sales@x-pole.co.uk
Tel: +44 (0) 208 449 4400
www.x-pole.co.uk

X-POLE USA
Email: info@xpoleus.com
Tel: +1 888 976 5387
www.xpoleus.com

X-POLE Australia
Email: sales@x-pole.com.au
Tel: +61 (0) 2 9589 2645
www.x-pole.com.au



X-POLE Korea
Email: xpolekorea@hanmail.net
Tel: +82 (0) 32 277 5882
www.xpolekorea.kr

X-POLE Asia
Email: sales@x-pole.asia
Tel: +86 (21) 6236 6090
www.xpolecn.com

X-POLE New Zealand
Email: sales@x-pole.co.nz
Tel: +64 (0) 9 528 0998
www.x-pole.co.nz

Warranty

This product has been manufactured and tested to the highest quality standards by X-POLE. This Limited Warranty offered by X-POLE covers defects in material or workmanship in new X-POLE products for a period of 6 months.

This warranty extends to the original purchaser only and is non-transferable. Only consumers purchasing X-POLE products from authorised X-POLE retailers or resellers or through the X-POLE website may obtain coverage under our limited warranties.

What is covered?

X-POLE warrants this product against defects in material or workmanship as follows:

X-POLE, at its own discretion, will replace at no charge, for parts only, replace any product or part of the product that proves defective because of improper workmanship and/or material, under normal installation, use, service and maintenance. If X-POLE is unable to provide a replacement and repair is not practical or cannot be made in a timely fashion, X-POLE may elect to refund the purchase price in exchange for the return of the product.

How Long Does The Coverage Last?

Our warranty periods are 6 MONTHS from the documented date of purchase, depending on the type of product and where it was purchased. This does not affect your statutory rights.

What Our Warranty Does Not Cover?

Our warranties do not cover any problem that is caused by:

- A.** Conditions, malfunctions or damage not resulting from defects in material or workmanship.
- B.** Conditions, malfunctions or damage resulting from (1) normal wear and tear, improper installation, improper maintenance, misuse, abuse, negligence, accident or alteration.
- C.** Accessories, connected materials and products, or related products not manufactured by X-POLE.
- D.** Defects from use, wear and tear, chipped edges from pole to pole contact or being dropped and anything outside of a pure manufacturing defect are not covered.

Due to the high specification mirror finish, small tube surface blemishes or stress lines may be visible. These do not detract away from the quality of use of the pole and are only cosmetic issues.

POWDER COATED POLES ONLY: The Powder Coating is susceptible to damage if the pole is dropped or scratched in any way. When installing X-Joints/adding extensions, be careful not to damage the powder coating. **DO NOT USE CHEMICAL BASED CLEANERS ON POWDER COATED POLES.**